

Bodenatmungs- und Substratnutzungsmessungen

WS10

- Mikrohabitate, Entstehung von CO₂ in Böden
- Messmethoden: MicroResp, Isermeyer, IRGA
- Aussagekraft für Systemzusammenhänge

Microhabitate im Boden

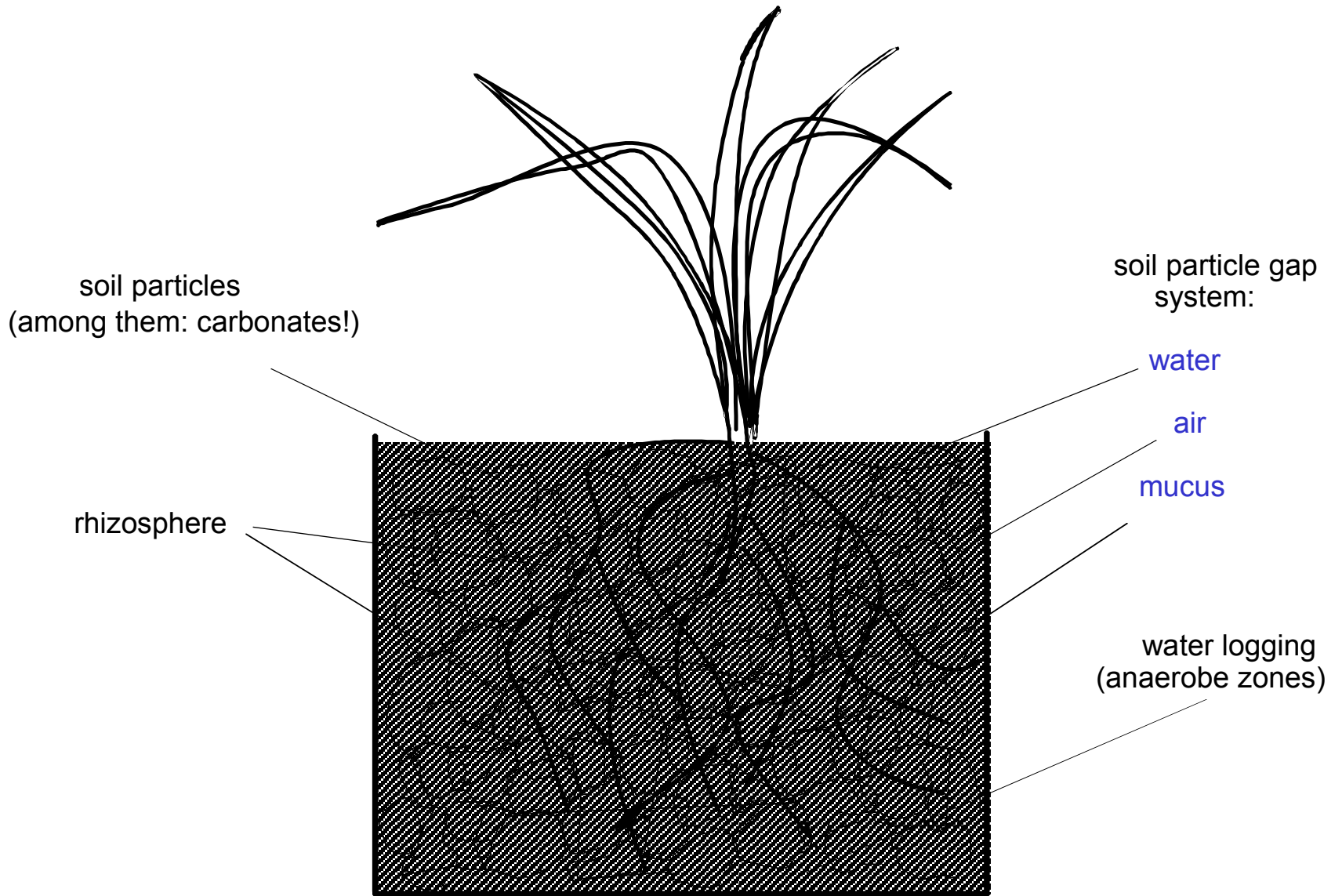

Das Karbonatsystem im Boden

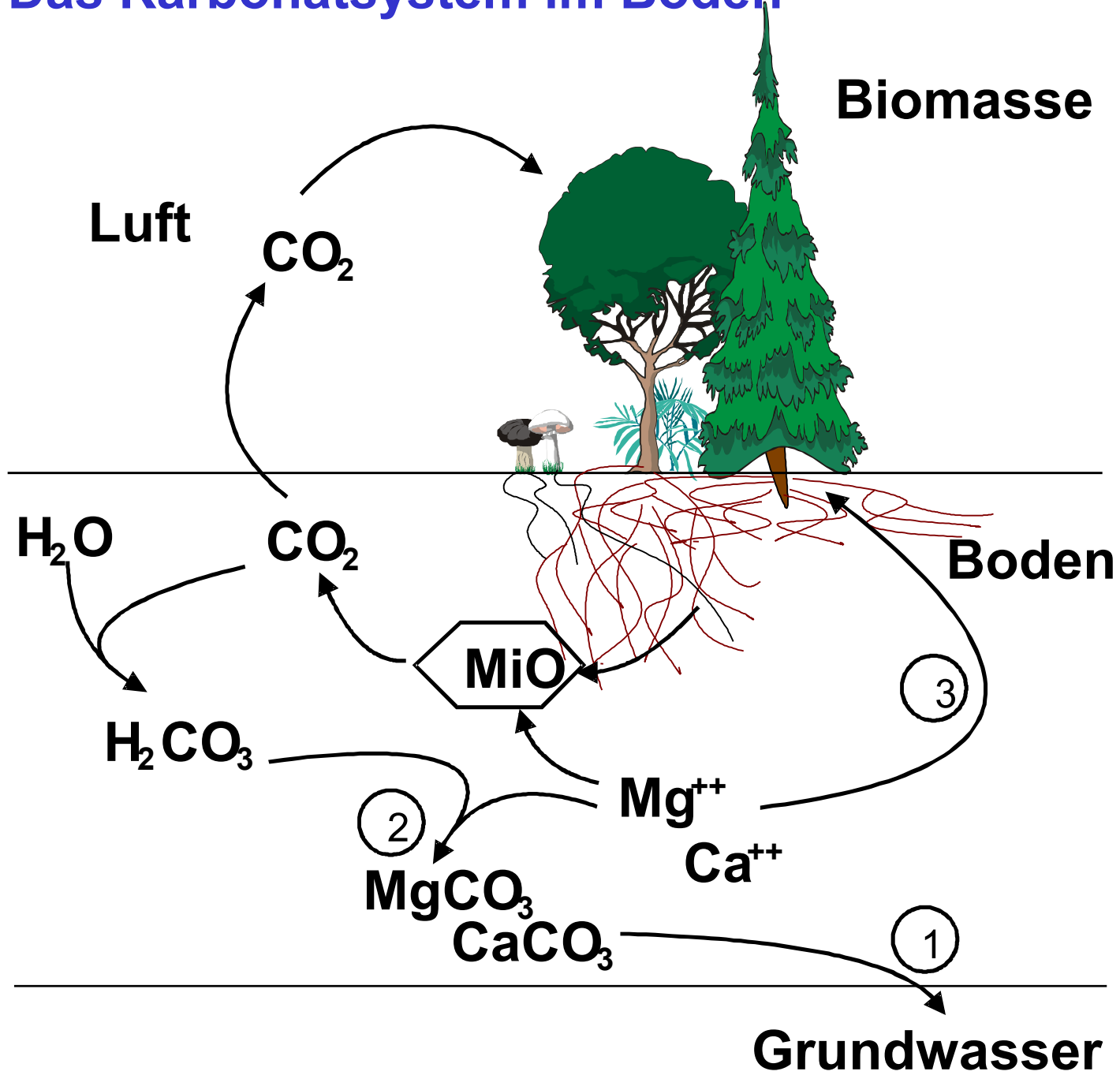

MicroResp Messsystem

D. The MicroResp™ Procedure in Brief



- 1 Place filling device over deepwell plate and fill with soil.



- 2 Remove sliding perspex sheet to allow soil to fall into deepwell plate.



- 3 Read detection plate at 570 nm (0 hrs) and assemble onto the deepwell plate with the MicroResp™ seal.



- 4 Place in metal clamp and incubate at 25°C for 6 hrs before re-reading detection plate at 570 nm.

(v) Calibration of MicroResp™

The MicroResp™ system requires calibration for individual laboratories to take into account different spectrophotometers, different types of environmental samples, and incubation conditions. The conversion of Absorbance to %CO₂ is a non-linear relationship and the best fitted curve (regression analysis) is used to obtain the formula and parameters.

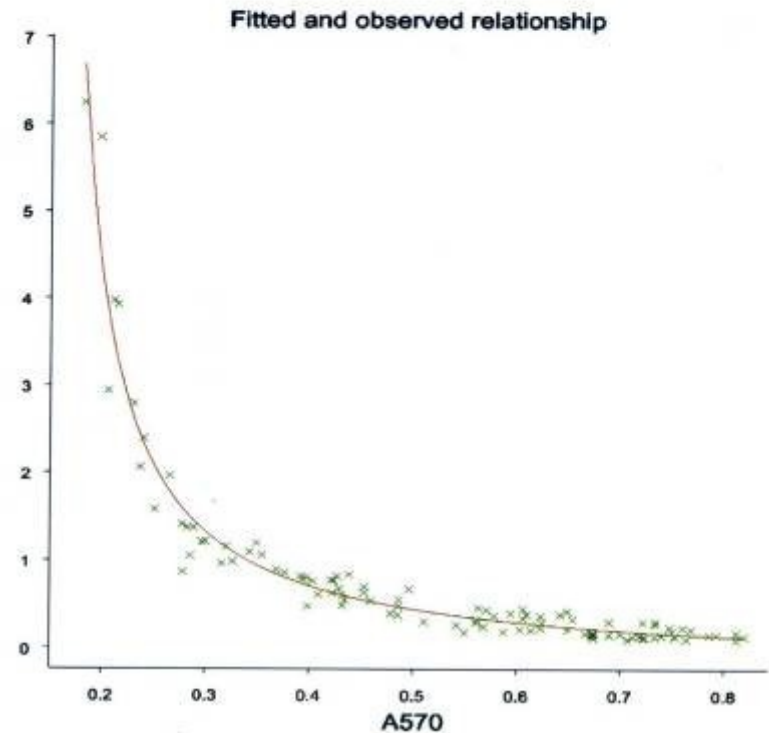

Rücktitration nach Isermeyer (1952)

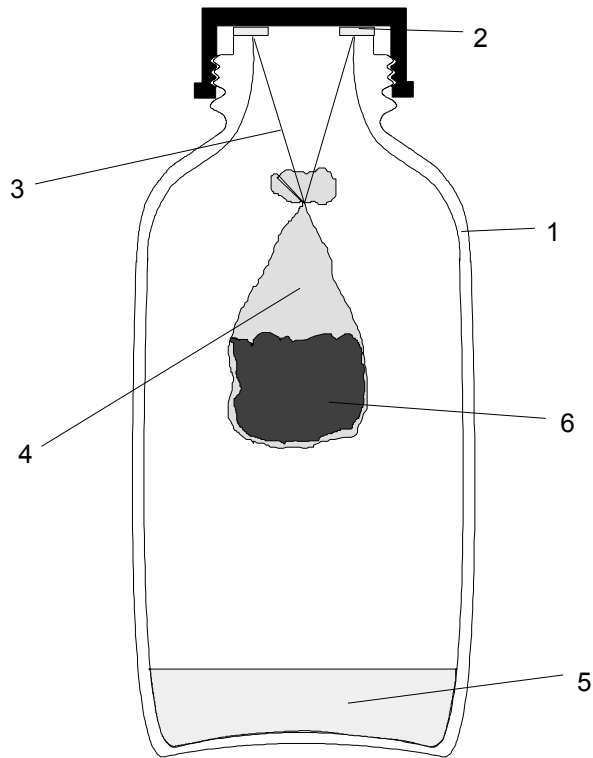

- 1... Schott- Flask
- 2... Sealing
- 3... Nylon Thread
- 4... Small Bag from Nylon Mesh
- 5... Sodiumhydroxide
- 6... Soil

IRGA (Infra Rot Gas Analyse)

14.2. Molekülschwingungen

Strackschwingungen

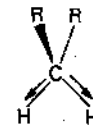

a) symmetrisch

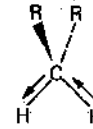

b) asymmetrisch

Deformationsschwingungen

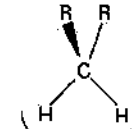

a) Scherschwingung (in der Ebene)

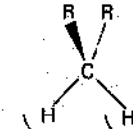

b) Pendelschwingung (in der Ebene)

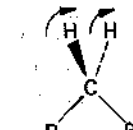

c) Kippschwingung (aus der Ebene)

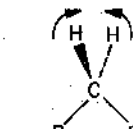

d) Torsionsschwingung (aus der Ebene)

Abb. 14-4. Einige Schwingungsarten der Methylengruppe.

CO₂ MODEL

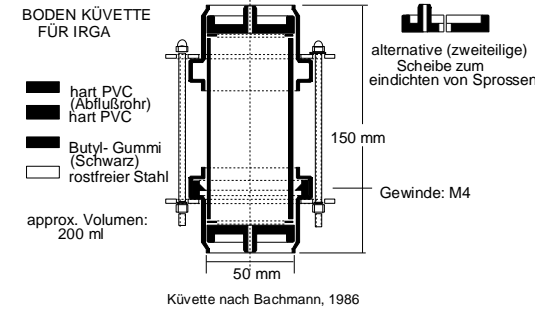
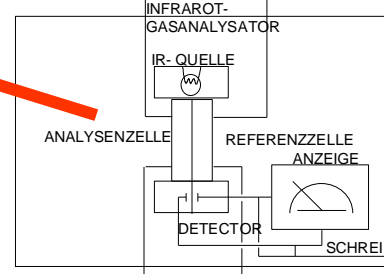
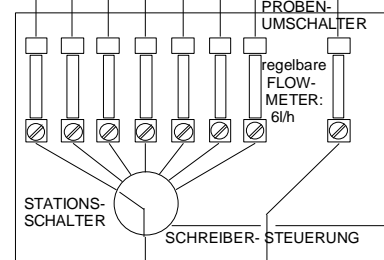
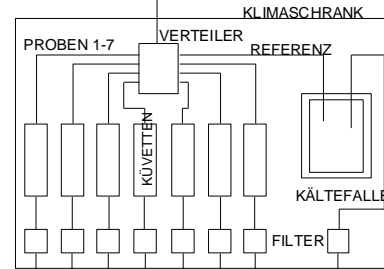
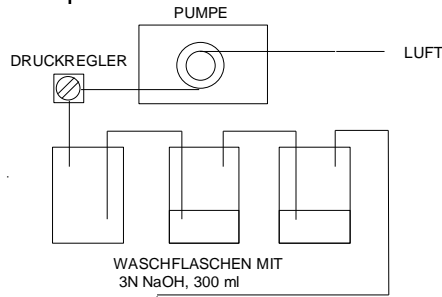
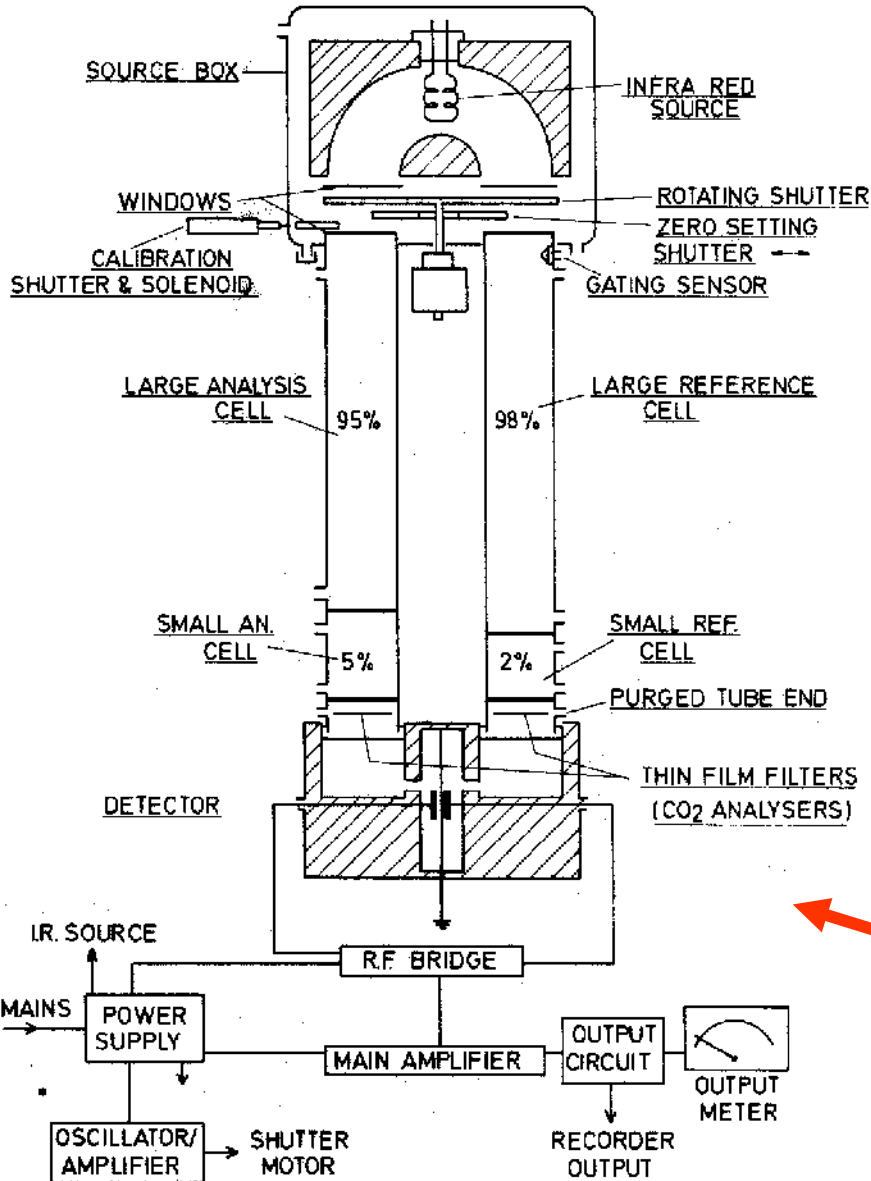

Versuchsanordnung nach Bachmann und Baumgarten, 1986

FIG 1

SCHHEMATIC DIAGRAM I.R. ANALYSER TYPE 225 MK 3 ISS. 1
THE ANALYTICAL DEVELOPMENT CO. LTD.

2b-3-7x1 95% & 98% CELLS ENTRY ADDED

Messpraxis mit IRGA im offenen Kreislauf BR, SIR, RESP

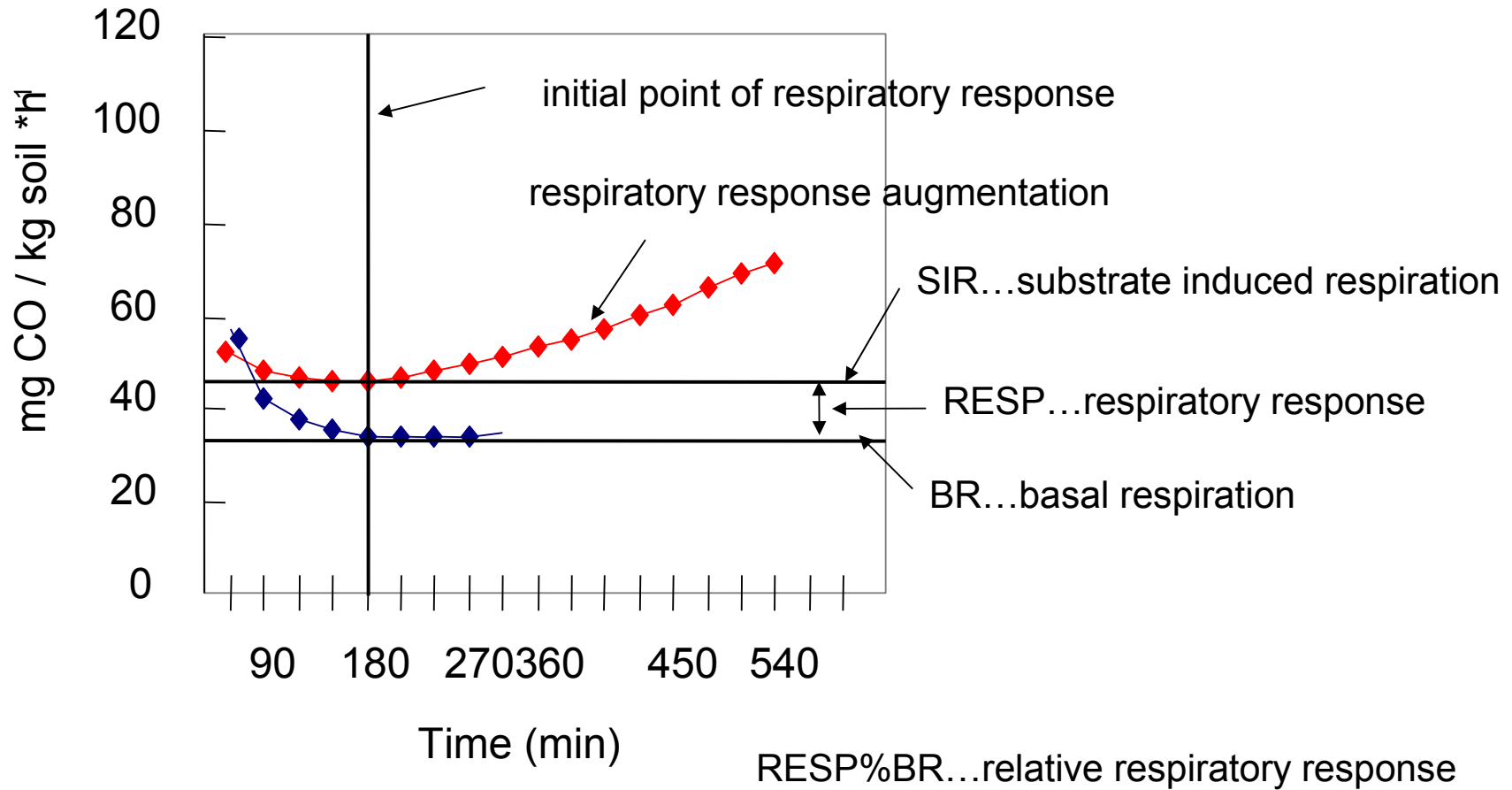

Mikrobielle Aktivität und Biomasse

